

Topics for Theses and Student Projects at LWET

General Information

- The topics listed in this document are suggestions for theses and student projects including
 - Bachelor theses,
 - Software Lab Projects / Pre-Theses and
 - Master theses.
- The specific task will be concretized in consultation with the student.
- Interested students are asked to contact the responsible person stated under contact via phone or e-mail.



Design and Installation of Remote Monitoring and Control of the H₂-Eco-Cube Using a Digital Twin

Background

At the Institute for Wind Technology, Energy Storage and Grid Integration (IWEN), an institute affiliated with the University of Rostock, an isolated system of energy generation, storage and consumption was developed. With the help of this system, the generation and use of hydrogen, as well as the operation with different management strategies, are to be tested. In the future, the self-contained solution is to be operated in a container away from the institute.

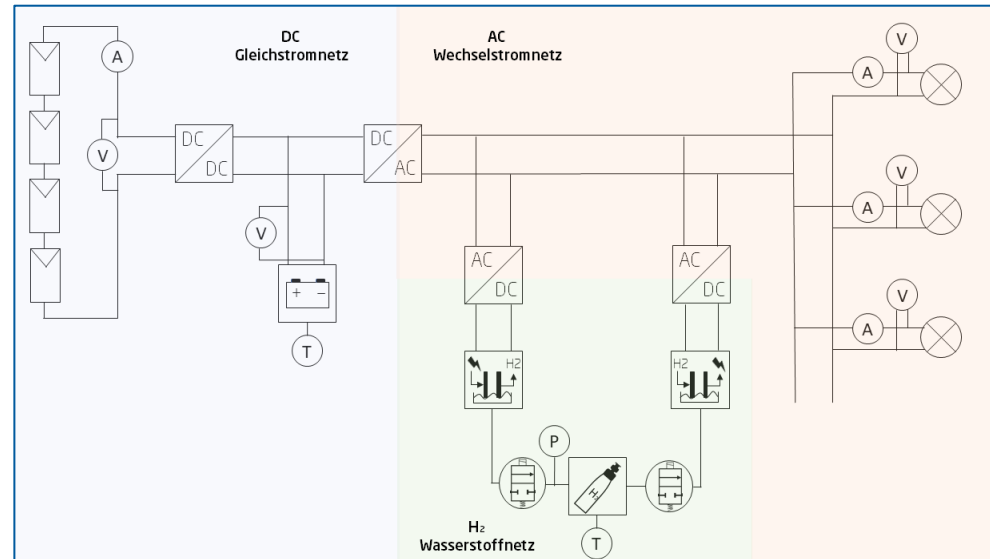

Reference: IWEN | Elmar Eichler

Task

The aim of the thesis is to enable remote monitoring and control of the H₂-Eco-Cube. To do this, it must first be determined whether and by which components the existing actuators and sensors need to be supplemented. In addition, the necessary information and communication technology must be determined, selected and installed. The information and communication technology has the task of collecting and forwarding all relevant status data of the energy system. Commands are to be sent to the energy system using the ICT. On the software side, a digital twin to be developed in the work is to be used to collect, display and monitor the data. Ultimately, this digital twin can be used to influence system behavior. In addition, the digital twin must be able to make virtual changes to the system in order to be able to use simulations to evaluate what impact these changes would have on the system behavior.

Study on the WT Rotor Blade Eigenmodes with exact Calculation of Stiffness and Inertia Values of Airfoil Cross Sections

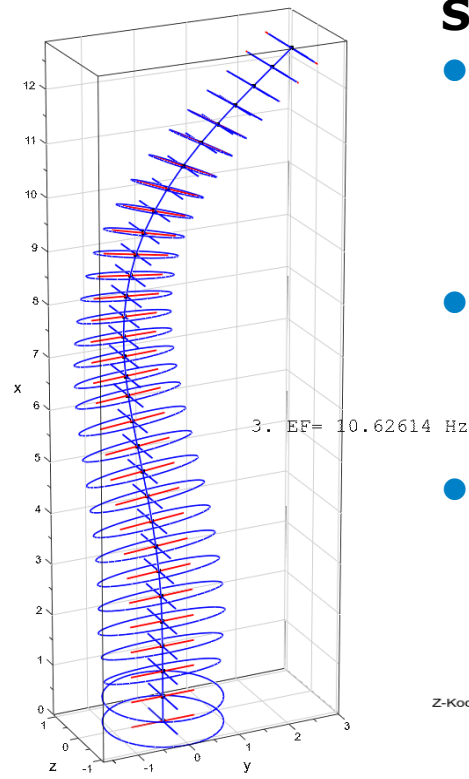
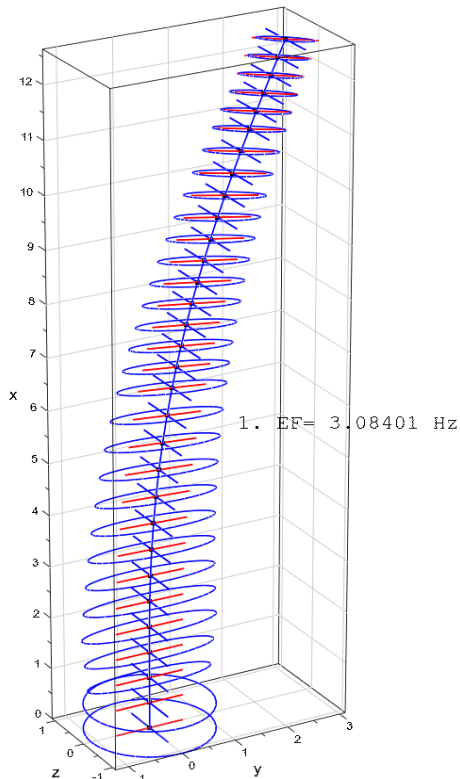

Scope

- Parameter study using existing C# program code for cross-section value calculation, especially with exact calculation of torsional stiffness based on actual multi-layer rotor blade design
- Comparison calculations with an FE-model of a 3D beam implemented in a C# code, using realistic rotor blade data and accounting for twist angle and pre-curvature
- Literature review and approaches to estimating the shear coefficient in the Timoshenko beam model for laminate materials

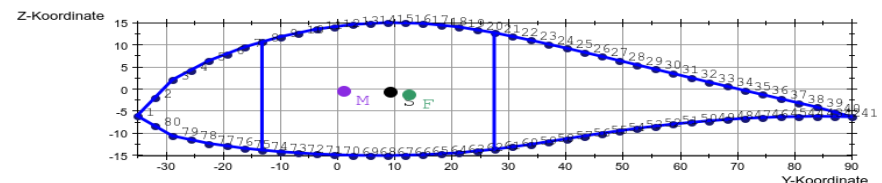

Eigsolver Procedures for Determination of Eigenmodes of WT Rotor Blades in a C# program

Scope

- Using and Testing the subspace iteration procedure in the present C# program
- Implementing a second suitable procedure for solution of the eigenvalue problem by searching in free software source codes and/or math-libraries
- Performing test calculations with these methods and comparing with existing eigenfrequencies and eigenmodes for generic WT rotor blades

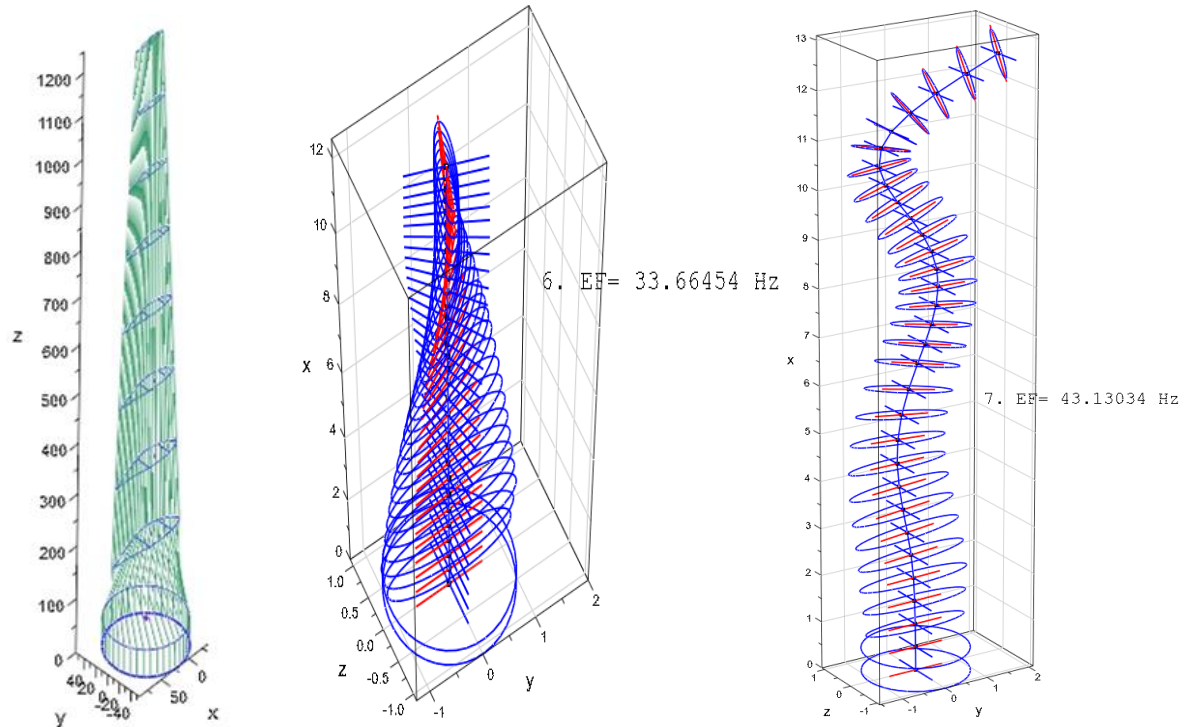

Modeling the Aerodynamic Damping in WT Rotor Blades by Using the Transfer Matrix Method in C#-Code

Scope

- Implementing the calculation of a damping matrix based on numerical integration of the DGI system for the 3D-Bernoulli-beam model in the existing C#-program
- Testing of different approaches for modeling the aerodynamic damping as a non-proportional damping component
- Using the extended C#-Code, performing and discussing the test calculations on the vibration behaviour of the rotor blade

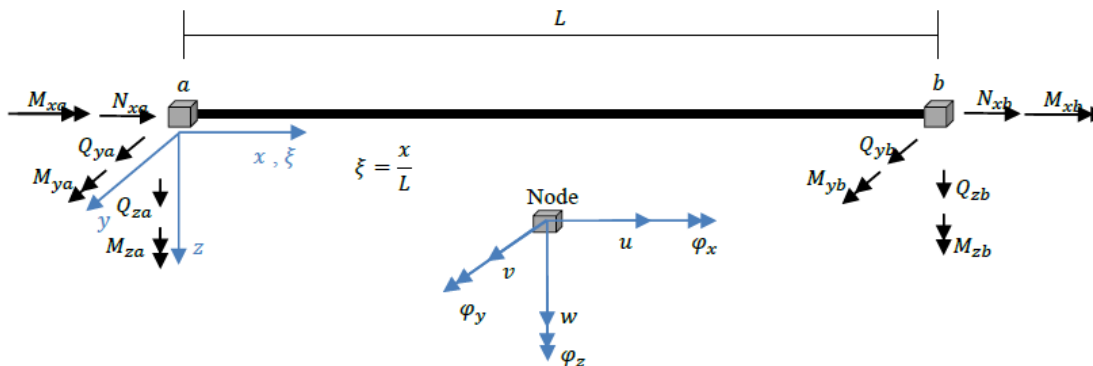
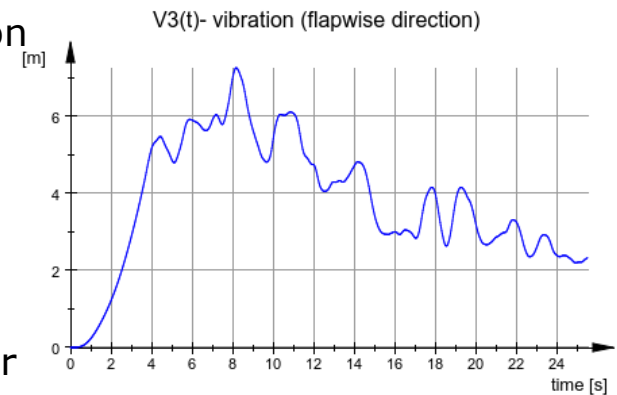

The finite beam element - internal forces and nodal DOFs

